



Satisfy Professional's Needs

# Plate Joiner PJ7000

## PRECISION GROOVING

Slim motor housing with an extra-ergonomic barrel grip



Glue and a biscuit inside each slot creates a strong seam.

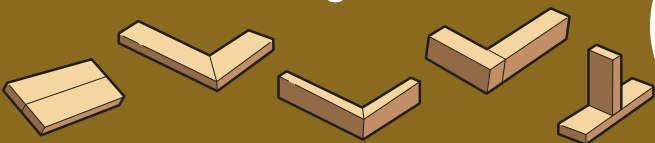



# Compact and lightweight design for high maneuverability and easy handling



## Connectable to vacuum cleaner

Dust nozzle can be rotated towards a desired direction of dust ejection.



## Angle guide

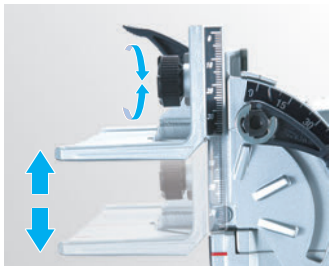

Angle guide can be raised and lowered with rack and pinion mechanism, allowing fine vertical adjustment.

## Angle adjustable fence



Angle adjustable fence can be locked in any position between 0° and 90° with positive stops at 0°, 45° and 90°.

## Depth adjusting knob



Cutting depth can be preset in 6 stages by simply rotating the depth adjusting knob (stopper).

## Easy blade replacement

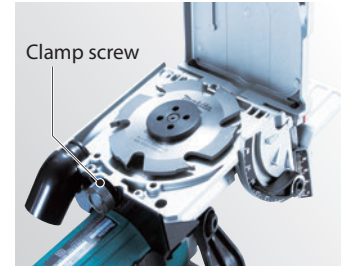

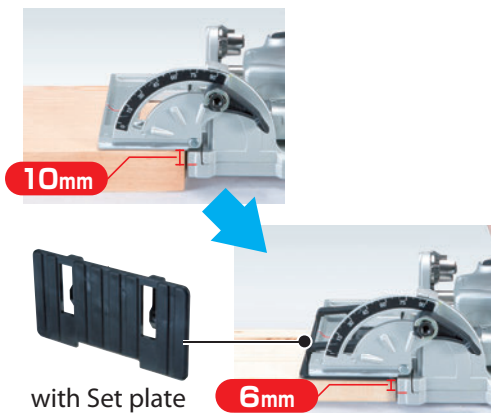

Blade cover can be opened just by loosening clamp screw.



## Plate Joiner



-  Double Insulation
-  Dust Collecting
-  Carrying Case

## PJ7000

459

<b>Continuous rating Input</b>	701W
<b>Blade diameter</b>	100mm (4")
<b>No load speed (rpm)</b>	11,000
<b>Dimensions (L x W x H)</b>	302x139x145mm
<b>Net Weight*</b>	2.5kg (5.6lbs)
<b>Power supply cord</b>	2.5m (8.2ft)

### Standard Equipment :

Cutter Blade, Angle Guide, Dust Bag, Set Plate, Lock Nut Wrench

\*Weight according to EPTA-Procedure 01/2003

Items of standard equipment and specifications may vary by country or area.

## Makita Corporation

3-11-8 Sumiyoshi-cho, Anjo, Aichi, 446-8502 Japan

PRINTED IN JAPAN BC-AB